

SOVET

ITALIA



Cadira / Cadira S

collection booklet

collection booklet

Cadira

Design **Studio Sovet**

“
A seating with an enveloping and comfortable shape that matches with elegance and simplicity the tables of Sovet’s collection. The Cadira chair finishes, from leather and fake leather to fabric and velvet, complete the different types of structure making it adapt for any kind of public or private space.

Una seduta dalla forma comoda ed avvolgente che accompagna con raffinatezza e semplicità i tavoli della collezione Sovet. Le finiture di Cadira, dalla pelle e ecopelle fino al tessuto e al velluto, si uniscono a diverse tipologie di struttura personalizzando la seduta per gli interni pubblici e privati.

”

Models & Dimensions

Chair with armrests. Available with three versions of lacquered metal bases, various finishes. Upholstered in various materials and finishes.

Sedia/poltroncina con braccioli. Disponibile con tre versioni di basi verniciate, varie finiture. Rivestimento in vari materiali e finiture.

Cadira wire

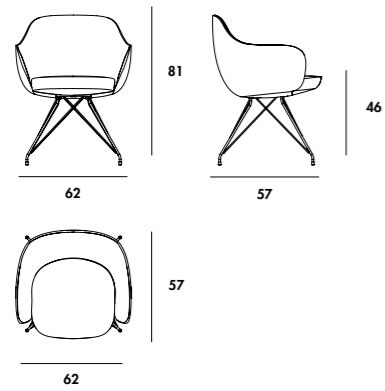

P8270
wire

Cadira swivel

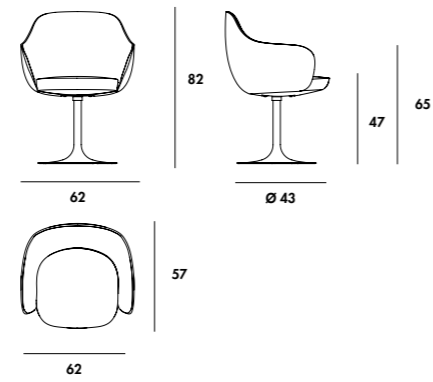

P8274
swivel

Cadira S wire

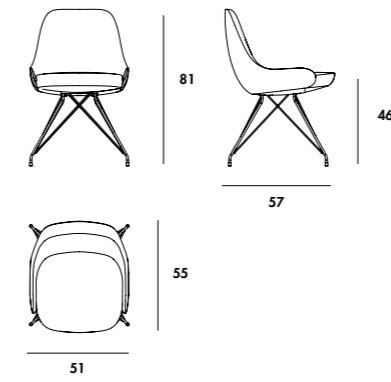

P8272
wire

Cadira S swivel

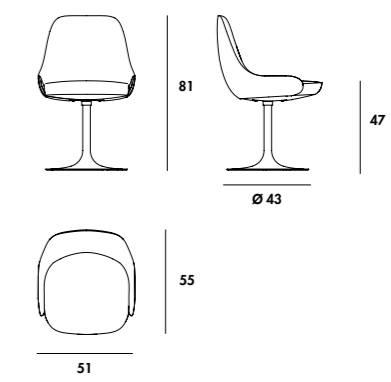

P8275
swivel

Cadira cone shaped

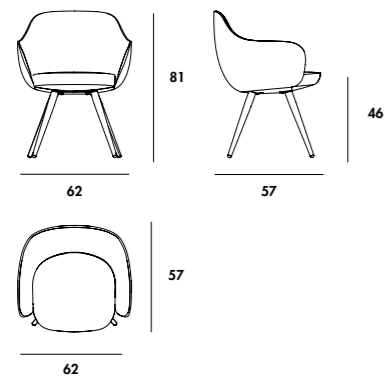

P8271
cone shaped

Cadira S cone shaped

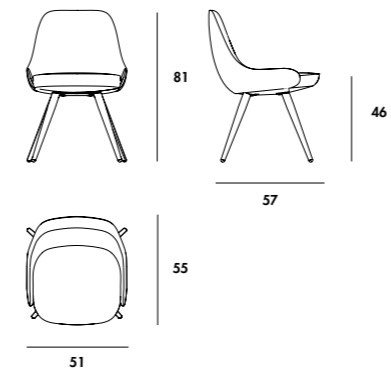

P8273
cone shaped

collection
finishes



seat / seduta

Leather Pelle

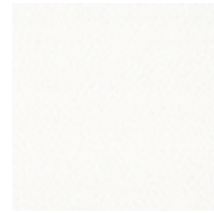

P50
White
Bianco



P61
Brown
Marrone



P53
Black
Nero



P54
Mocha
Caffè



P63
Off-white
Panna

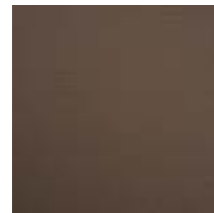

P64
Umber
Terra

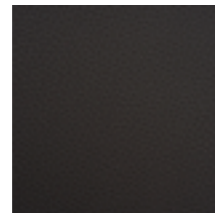

P65
Grey
Grigio

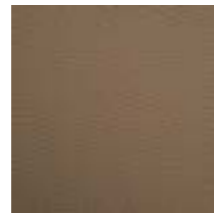

P67
Taupe
Talpa

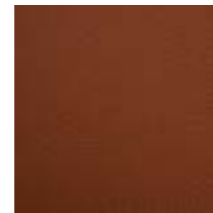

P68
Burnt Sienna
Terra di Siena

Ecopelle Nabuk Nabuk Fake Leather



P50
Thyme
Timo



P61
Grey
Grigio



P53
Beige
Panna



P54
Mocha
Caffè



P63
Anthracite
Antracite



P64
Brown
Marrone

Ecopelle Fake Leather



E20
Caramel
Caramello

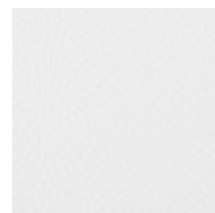

E21
White
Bianco



E22
Dove grey
Tortora



E23
Mocha
Caffè



E24
Black
Nero



E25
Brown
Marrone

Cura

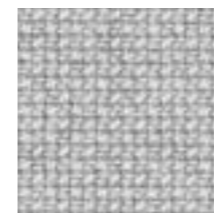

F30
Cura 6000

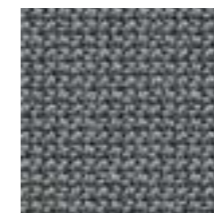

F31
Cura 60100

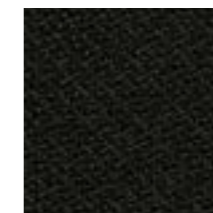

F32
Cura 60999



F33
Cura 61168

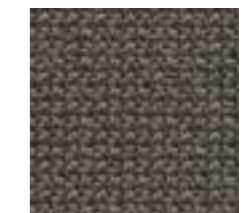

F34
Cura 61169

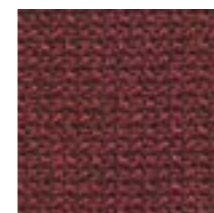

F35
Cura 64196



F36
Cura 66167



F37
Cura 68182



F38
Cura 68261

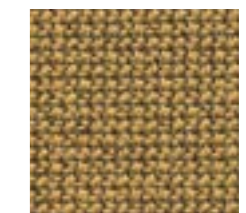

F38
Cura 62083

structure / struttura

Paddington



F40
Paddington 1

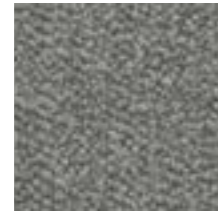

F41
Paddington 11



F42
Paddington 15

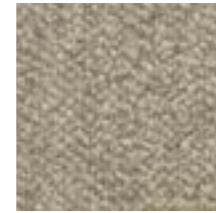

F43
Paddington 2

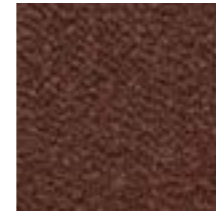

F44
Paddington 3



F45
Paddington 4

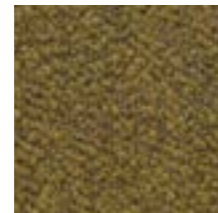

F46
Paddington 6

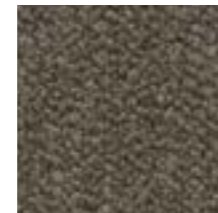

F47
Paddington 8

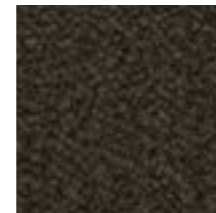

F48
Paddington 9

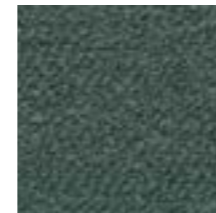

F49
Paddington 12

Velluto Velvet



Z01
Velvet 807



Z02
Velvet 904



Z03
Velvet 102

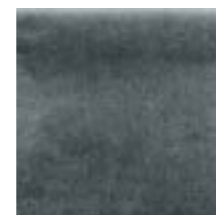

Z04
Velvet 803

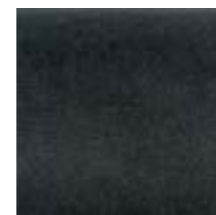

Z05
Velvet 801



Z06
Velvet 600



Z08
Velvet 400



Z09
Velvet 303

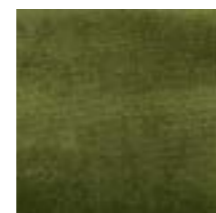

Z10
Velvet 505



Z24
Velvet 301

wire



GN
Embossed black
Nero gofrato



GB
Embossed white
Bianco gofrato



GC
Embossed Mocha
Caffè gofrato



GT
Embossed clay
Creta gofrato



BR
Burnished metal
Metallo Brunito

cone



GN
Embossed black
Nero gofrato



GB
Embossed white
Bianco gofrato



GC
Embossed Mocha
Caffè gofrato



GT
Embossed clay
Creta gofrato



BR
Burnished metal
Metallo Brunito

swivel



GN
Embossed black
Nero gofrato



GB
Embossed white
Bianco gofrato



GC
Embossed Mocha
Caffè gofrato



GT
Embossed clay
Creta gofrato

N.B. E' possibile la personalizzazione del rivestimento con tessuto cliente con costi e quantitativi da concordare.

Customization of the upholstery with COM fabric is possible with costs and quantities to be agreed on.

Vetro

Le laccature utilizzate non presentano problemi di durata: basta evitare graffi e urti contro oggetti particolarmente duri e spigolosi. Il vetro è colorato solo sulla faccia posteriore sia nei vetri laccati coprenti mono e bicolore che nei vetri acidati laccati. La tonalità dei campioni proposti è indicativa e non va pertanto intesa in senso restrittivo; può infatti differire leggermente in conformità ai margini di tolleranza riconosciuti per i materiali impiegati. I materiali impiegati possono essere puliti tranquillamente solo con acqua oppure con un detergente neutro. Evitare l'uso di abrasivi, acidi o reagenti chimici. Il vetro è interpretato attraverso la sua trasparenza, pertanto la conformità al campione può differire a seconda della superficie e degli spessori impiegati. Un esempio lampante è dato dal vetro extrachiaro che nei campioncini si presenta completamente neutro ma che nei piani di dimensioni maggiori e con spessori più consistenti assume sfumature azzurro/verdi. Per tale ragione vi preghiamo anche di segnalare con particolare attenzione articoli che debbano essere affiancati o facenti parte di una stessa commissione.

La finitura bicolore consiste nella doppia laccatura nella parte interna della lastra di vetro. La prima laccatura, visibile attraverso la trasparenza del vetro, è disponibile nelle categorie B-D. La seconda laccatura, visibile internamente, equivale al colore pastello opaco utilizzato per ottenere le finiture di cat. B. Vi facciamo presente che in questo caso l'effetto finale differisce da quello creato dalla medesima laccatura attraverso il vetro, in particolare nei colori tenui.

Specchi

Gli specchi oro e rosa potrebbero presentare delle piccole imperfezioni dovute alle caratteristiche tecniche del materiale. Non possono essere utilizzati in luoghi umidi. Pulire solo con panni asciutti.

Ceramica

I campioni riportati sono una parte delle lastre che vengono lavorate. La lastra completa si può vedere nella corrispondente cartella. Pulire utilizzando acqua e una piccola quantità di detergente neutro. Evitare l'utilizzo di detersivi contenenti cere e prodotti ceranti per evitare la formazione di strati untuosi.

Legno

I colori dei legni sono campioni indicativi. Pulire utilizzando un panno morbido inumidito.

Metalli

I colori dei metalli sono campioni indicativi. Pulire utilizzando un panno morbido inumidito.

Tessuti/Pelli/Ecopelli/Velluti

I colori dei tessuti sono campioni indicativi. Per la cura e la manutenzione fare riferimento alle indicazioni riportate nelle rispettive cartelle e alle schede tecniche fornite dai produttori.

Se permangono dubbi contattare l'azienda.

Glass

The lacquering used for our furniture is extremely durable as long as you avoid scratching it or bumping particularly hard/sharp objects against it. The glass is lacquered only on the back side both for mono or two-tones lacquered and frosted lacquered glasses. The shade of the samples is only indicative and has not to be taken as restrictive. It can in fact slightly differ in conformity to the tolerances recognized for the materials used. All the materials we use can be easily cleaned with water only or with a mild detergent. Do not use abrasive materials, acids or harsh chemicals. The glass is interpreted through its transparency, therefore the conformity to the sample might differ according to the surface and the thickness used. For example, the extralight glass is completely neutral when seen in the small samples, but it takes a light blue/greenish shade when used on bigger or thicker tops. For this reason, we beg you to indicate carefully those articles which have to be placed side by side or which are part of the same commission.

The two-tones finish consists of a double lacquering on the internal part of the glass sheet. The first lacquering, which is visible through the transparency of the glass, is available in the finishes of cat. B-D. The second lacquering, which is visible internally, is the same of the mat pastel used to get the finishes of cat. B. Please notice that the final effect is different from the one created by the same lacquering through the glass, in particular when it comes to soft colours.

Mirrors

Gold and rose mirrors could have small imperfections due to the particular technical characteristics of the material. We recommend not to use them in damp areas. Clean only with a dry cloth.

Ceramic

The shown samples are part of the bigger slabs Sovet works with. The complete slab is visible in the corresponding folder. Clean using water and a small amount of neutral detergent. Avoid using detergents with wax and waxing products to avoid the formation of greasy layers.

Wood

Wood colours are indicative samples. Clean using a damp soft cloth.

Metals

Metals colours are indicative samples. Clean using a damp soft cloth.

Fabrics/Leathers/Fake leathers/velvets

Fabrics colours are indicative samples. For care and maintenance please refer to the instructions present in the corresponding folders and to the technical sheets provided by the manufacturers.

In case of further doubt please get in touch with the factory.



Cadira wire structure GN seat 190 Hallingdal.
Visual structure GC mirror SESP.



Cadira wire structure GN seat 190 Hallingdal.
Kodo structure GN top CU.



In the previous page
Cadira cone shaped structure BR seat Z09.
Deod two bases BR top MESP.



Cadira wire structure GN seat 190 Halligndal.
Cadira wire structure GN seat 674 Halligndal.





Cadira S wire structure GN seat Hallingdal 103.
Slim table structure GN top CQ.



Cadira S swivel structure GC seat Z03.
Slim table structure GC top CU.



Cadira cone shaped structure GN seat P53.
Magda suspended structure CF doors SESP.

designer

Studio Sovet

Studio Sovet is the development and design department of SO.VE.T. The team is composed of a group of figures that collaborate to create unique projects. For SOVETITALIA the good design raises in fact from the dialogue of ideas and concepts between people. The richness of this exchange leads to create unique products that resonate with their inner meanings of wisdom, craftsmanship and technology. These are the strengths of a company that has quality, design and service as a primary mission.

Studio Sovet è il dipartimento di sviluppo e progettazione di SO.VE.T. Il team è composto da un insieme di figure che collaborano tra di loro per creare progetti unici. Per SOVETITALIA il buon design, infatti, nasce dal dialogo di idee e concetti tra le persone. La ricchezza di questo scambio porta a creare dei prodotti unici che richiamano al loro interno i significati di sapienza, artigianalità e tecnologia. Questi sono i punti di forza di un'azienda che fa della qualità, del design e del servizio al cliente una mission.

SOVET
ITALIA

sustainability is made up of facts.

Sovet has always maintained a high attention to eco-compatibility since its birth in 1987, through the selection of raw materials and the study of production processes that have the lowest impact on the environment with the aim of creating long-lasting products.

Sovet ha sempre mantenuto alta l'attenzione all'ecocompatibilità sin dalla sua nascita nel 1987, attraverso la selezione delle materie prime e lo studio di processi produttivi che abbiano il minimo impatto sull'ambiente con lo scopo di creare prodotti durevoli nel tempo.

photovoltaic systems

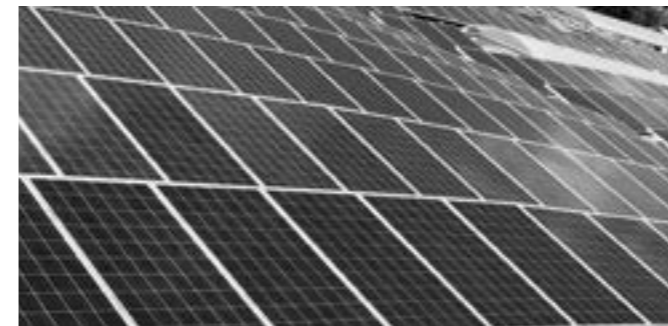

For its production processes, Sovet uses energy coming directly from renewable sources. Thanks to its photovoltaic systems, it is able to meet its own energy demand.

Per la sua produzione Sovet utilizza infatti energia derivante direttamente da fonti rinnovabili. Attraverso impianti fotovoltaici riesce a soddisfare il proprio fabbisogno energetico.



502695,549 kg emmissions saved per year



2989 trees saved per year



165 barrels of oil saved per year

packaging



Sovet uses cardboard packaging with limited presence of oil-derivates.

Sovet usa imballi di cartone costruiti ad hoc con limitata presenza di derivati del petroli.



reducing plastic is an habits



To reduce the consumption of plastic and disposable bottles within its offices and production, Sovet created metal water bottles.

Per ridurre il consumo di plastica e bottiglie monouso all'interno dei suoi uffici e della produzione, Sovet ha creato delle borracce in metallo.

made in italy

The creative use of industrial processes, the use of raw materials of highest quality and the scrupulous work of master craftsmen, allow Sovet to create high quality and 100% Made in Italy collections. Thanks to state-of-the-art industrial automation systems, Sovet is also able to meet also large supply needs for contract spaces, always granting the highest quality standards. The company takes a continuous search path for materials, to create an offer of accessories that complement one another, furnishing different kinds of environments with the maximum freedom when it comes to customization.

L'impiego creativo dei processi industriali, l'utilizzo di materie prime di assoluta qualità e le scrupolose lavorazioni eseguite da maestranze artigiane, permettono a Sovet di ottenere collezioni di alta qualità e 100% Made in Italy. Grazie a sistemi di automazione industriale all'avanguardia Sovet è in grado di soddisfare anche esigenze per grandi forniture destinate a spazi contract, sempre garantendo i più elevati standard qualitativi. Sovet intraprende un percorso di ricerca dei materiali per creare un'offerta di complementi che si integrino tra di loro, arredando varie tipologie di ambienti con la massima possibilità di personalizzazione.





[sovet.com](https://www.sovet.com)