

BONALDO

AX

Designer: Gino Carollo



Geometric essentiality and linearity are the choices of a design language for the AX rectangular extendable dining table based on simplicity but also solidity, underlined by the sizeable base. The appeal of the material contrast between the top and the legs makes any decoration almost superfluous, enhancing the purity of the design and Bonaldo's handcrafted excellence. The juxtaposition of very different materials underlines the contemporary feel of the design: the legs are offered in painted metal of numerous colours or burnished finish; the top, both in the fixed and extendable versions, is available in wood or ceramic. A console with the same name (AX Console) is also available for creating rooms with a coordinated style.



Data sheet

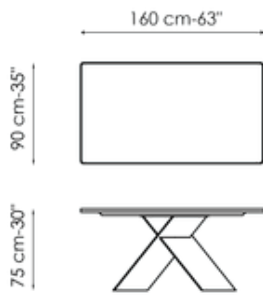

Width: 160cm
Depth: 90cm
Height: ± 75cm

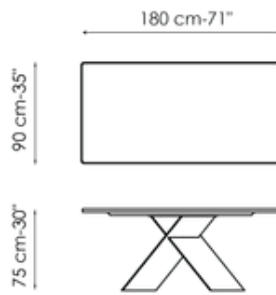

Width: 180cm
Depth: 90cm
Height: ± 75cm

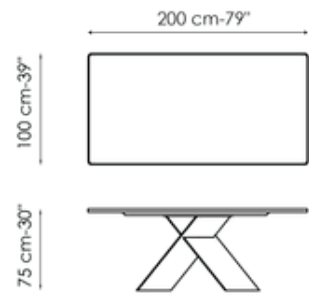

Width: 200cm
Depth: 100cm
Height: ± 75cm

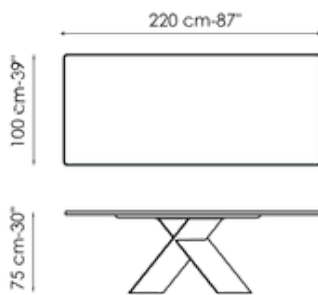

Width: 220cm
Depth: 100cm
Height: ± 75cm

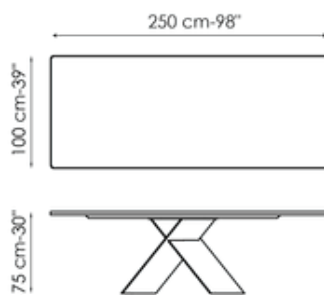

Width: 250cm
Depth: 100cm
Height: ± 75cm

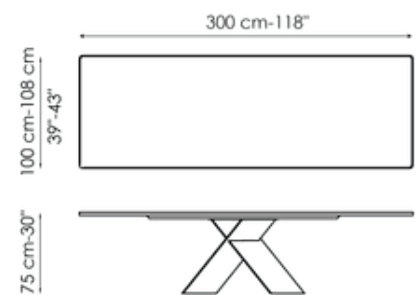

Width: 300cm
Depth: 100-108cm
Height: ± 75cm

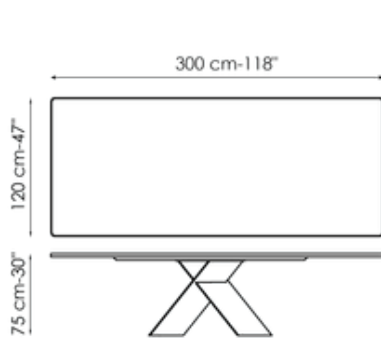

Width: 300cm
Depth: 120cm
Height: ± 75cm

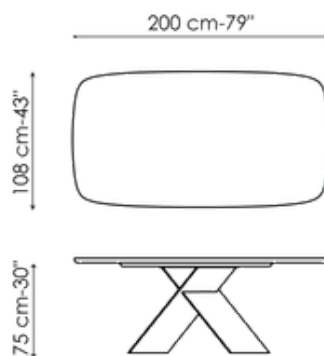

Width: 200cm
Depth: 108cm
Height: ± 75cm

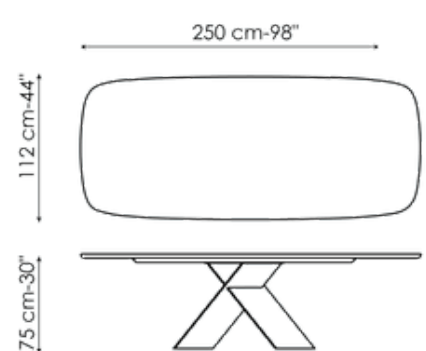

Width: 250cm
Depth: 112cm
Height: ± 75cm

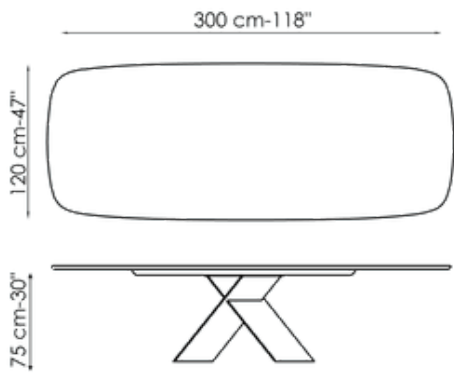

Width: 300cm
Depth: 120cm
Height: ± 75cm

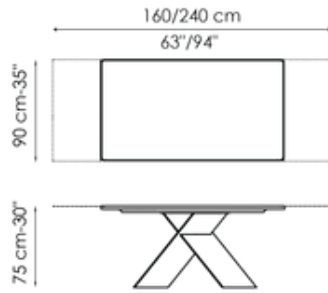

Width: 160-240cm
Depth: 90cm
Height: ± 75cm

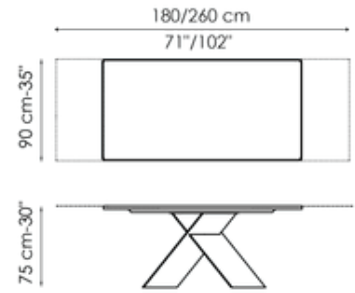

Width: 180-260cm
Depth: 90cm
Height: ± 75cm

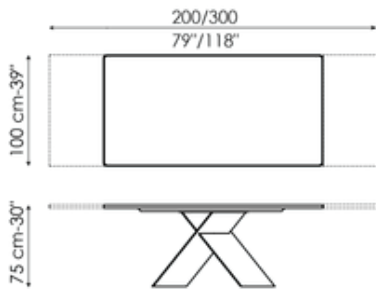

Width: 200-300cm
Depth: 100cm
Height: ± 75cm

Finishes

Rectangular top

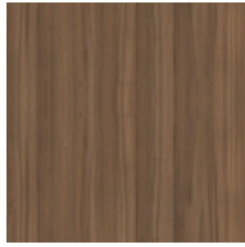

Veneered wood
Walnut Canaletto



Veneered wood
Brushed natural oak

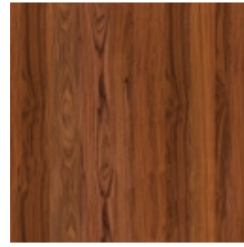

Wood with natural edges
American walnut

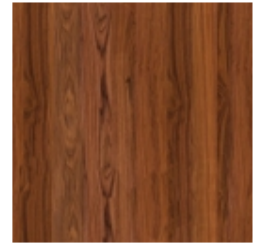

Solid wood
American walnut



Solid wood
Brushed natural oak



Solid wood
Brushed coal oak



Silk finish ceramic
Calacatta macchia vecchia



Glossy ceramic
Calacatta

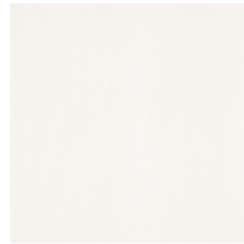

Mat ceramic
Iridium white

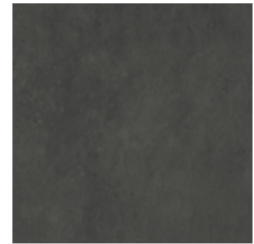

Mat ceramic
Graphite grey

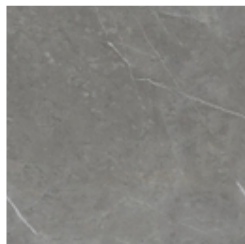

Mat ceramic
Ardesia grey

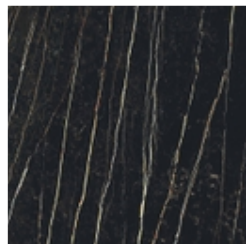

Mat ceramic
Laurent

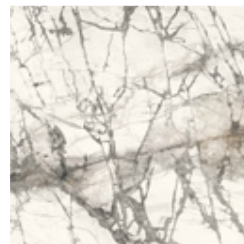

Glossy ceramic
Imperial grey

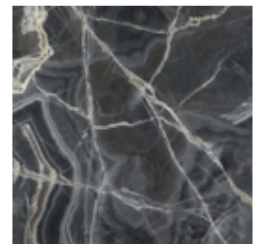

Glossy ceramic
Black Onyx



Glossy ceramic
Mountain peak

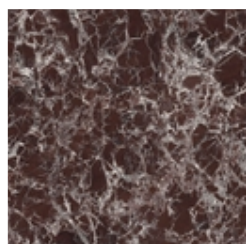

Glossy ceramic
Rosso imperiale

Barrel-shaped top

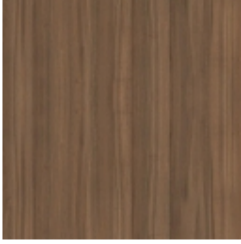

Solid wood
Walnut Canaletto

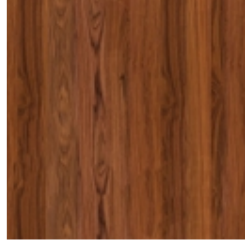

Solid wood
American walnut



Solid wood
Brushed coal oak

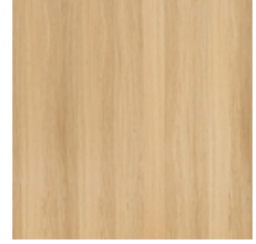

Solid wood
Brushed natural oak

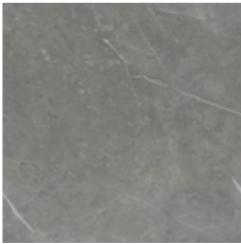

Mat ceramic
Ardesia grey



Glossy ceramic
Calacatta



Silk finish ceramic
Calacatta macchia vecchia

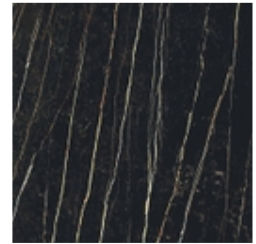

Mat ceramic
Laurent

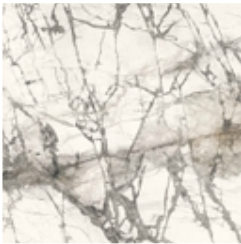

Glossy ceramic
Imperial grey

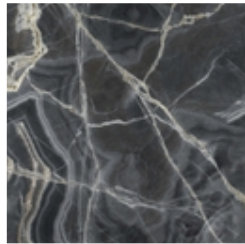

Glossy ceramic
Black Onyx

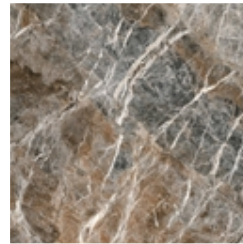

Glossy ceramic
Mountain peak

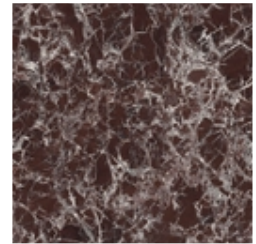

Glossy ceramic
Rosso imperiale

Leaf table top

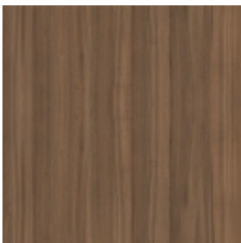

Veneered wood
Walnut Canaletto



Veneered wood
Brushed natural oak



Veneered wood
Brushed coal oak

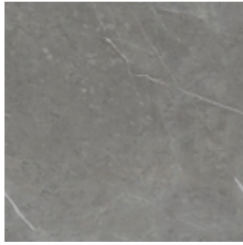

Mat ceramic
Ardesia grey

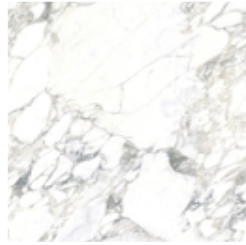

Glossy ceramic
Calacatta



Silk finish ceramic
Calacatta macchia vecchia

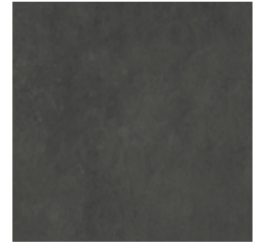

Mat ceramic
Graphite grey



Mat ceramic
Iridium white

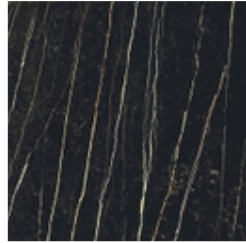

Mat ceramic
Laurent

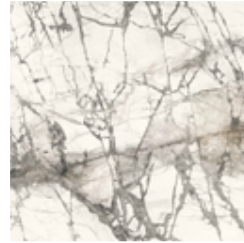

Glossy ceramic
Imperial grey

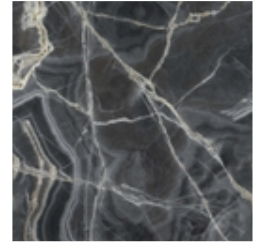

Glossy ceramic
Black Onyx



Glossy ceramic
Mountain peak

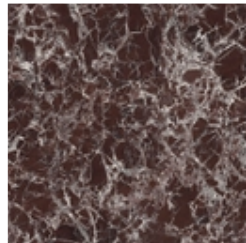

Glossy ceramic
Rosso imperiale

Base



Painted metal
Mat dove grey

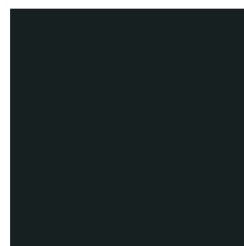

Painted metal
Mat black

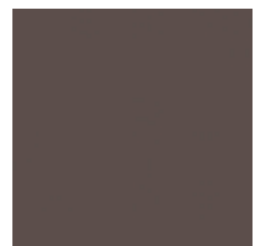

Painted metal
Mat brown

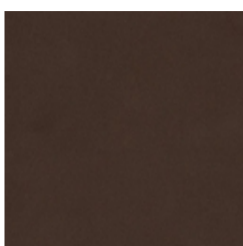

Painted metal
Mat bronze

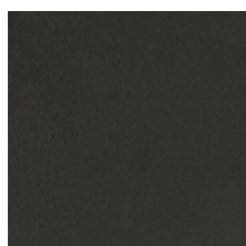

Painted metal
Mat lead



Painted metal
Mat pearl gold



Painted metal
Mat brass



Painted metal
Mat copper

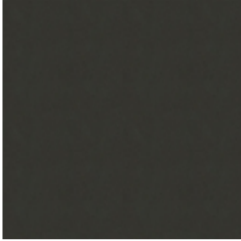

Metal finish
Burnished

Materials, fabrics, leathers, colors and finishes are approximate and may slightly differ from actual ones. You can find the complete collection of Bonaldo fabrics and leathers on the website <https://bonaldo.biz>