

BONALDO

Cop

Designer: Roberto Paoli



In everyday life, tables are normally covered with various objects but the surface of the Cop tabletop, with its innovative table leg design, is like a stretch of water on which the objects are upturned to form its unusual base. Stylised elements inspired by bottles, precious chalices and champagne glasses, appear in various shapes and sizes and are immediately striking, even in their unusual position. The top is a neutral element yet, at the same time, it is the dividing line of the world that it reflects. Flexible lines and careful formal research create a table intended to bring people and ideas together. The base of the Cop table is in painted metal, in a single colour or in burnished, matt brass or matt copper finishes. The fixed top is available in wood, ceramic or marble and can be round or with rounded edges.



Data sheet

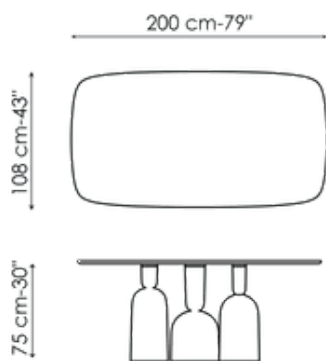

Width: 200cm
Depth: 108cm
Height: ± 75cm

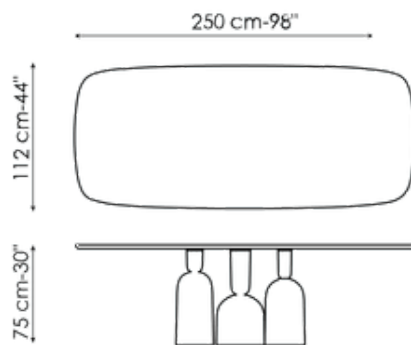

Width: 250cm
Depth: 112cm
Height: ± 75cm

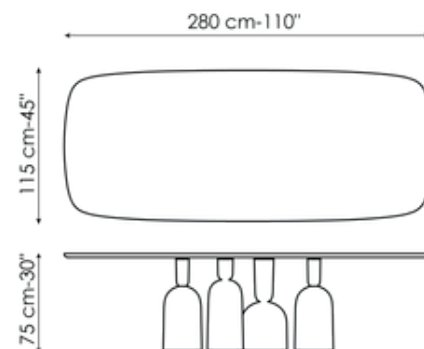

Width: 280cm
Depth: 115cm
Height: ± 75cm

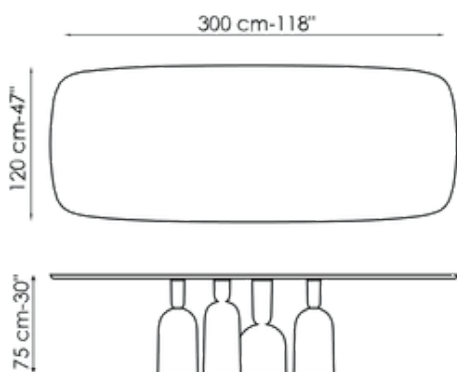

Width: 300cm
Depth: 120cm
Height: ± 75cm

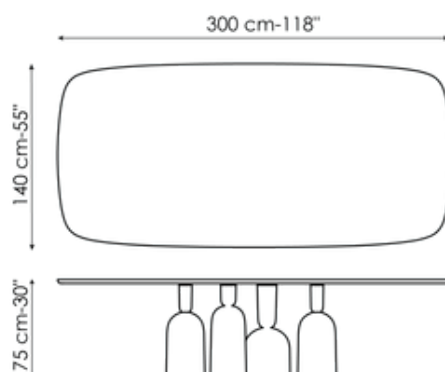

Width: 300cm
Depth: 140cm
Height: ± 75cm

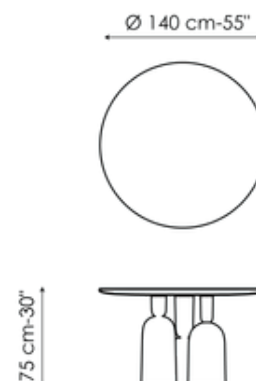

Width: 140cm
Depth: 140cm
Height: ± 75cm

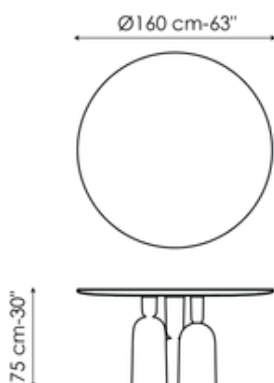

Width: 160cm
Depth: 160cm
Height: ± 75cm

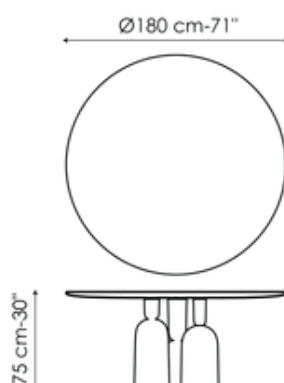

Width: 180cm
Depth: 180cm
Height: ± 75cm

Finishes

Barrel-shaped top

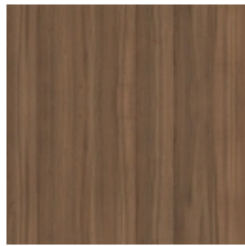

Veneered wood
Walnut Canaletto

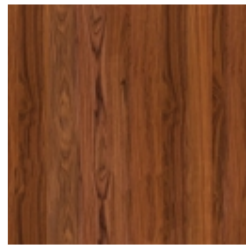

Solid wood
American walnut



Solid wood
Brushed natural oak



Solid wood
Brushed coal oak

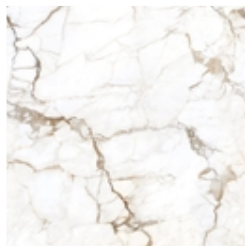

Silk finish ceramic
Calacatta macchia vecchia



Glossy ceramic
Calacatta



Mat ceramic
Ardesia grey

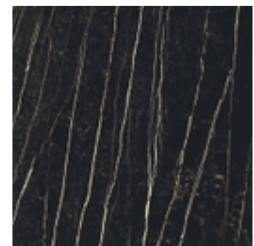

Mat ceramic
Laurent

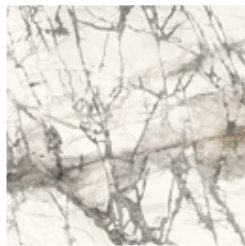

Glossy ceramic
Imperial grey

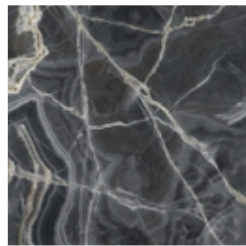

Glossy ceramic
Black Onyx

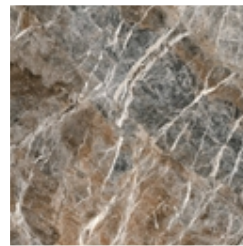

Glossy ceramic
Mountain peak

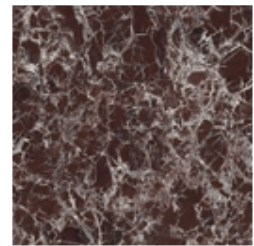

Glossy ceramic
Rosso imperiale

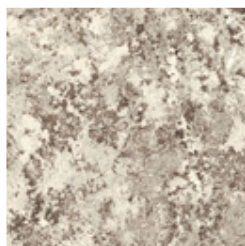

Mat ceramic
Alaska White



Mat ceramic
Augusta

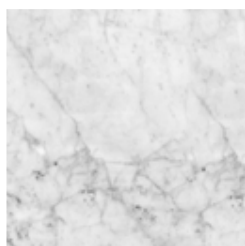

Marble
Carrara

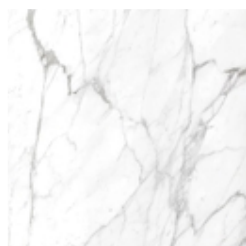

Marble
Calacatta

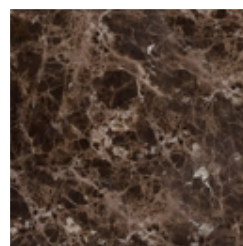

Marble
Emperador

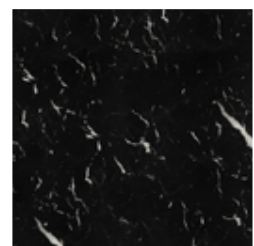

Marble
Marquinia

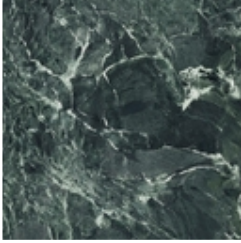

Marble
Saint Denis

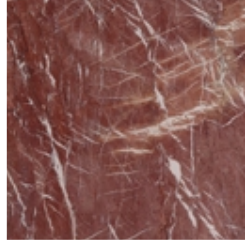

Marble
Rosso Carpazi



Marble
Fior di bosco

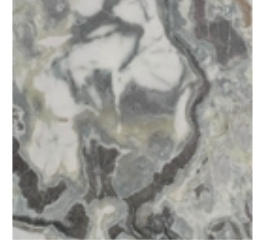

Marble
Dover White



Marble
Travertino Romano

Round top



Solid wood
Brushed natural oak



Solid wood
Brushed coal oak

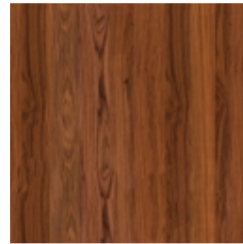

Solid wood
American walnut

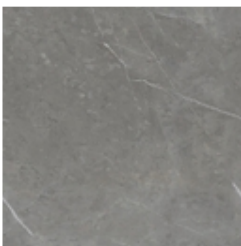

Mat ceramic
Ardesia grey

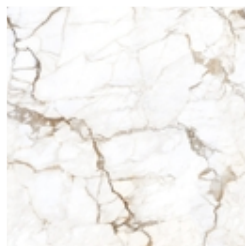

Silk finish ceramic
Calacatta macchia vecchia



Glossy ceramic
Calacatta

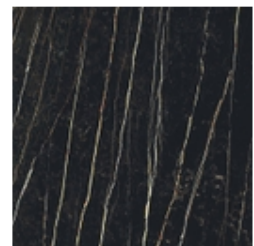

Mat ceramic
Laurent

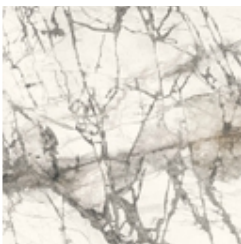

Glossy ceramic
Imperial grey

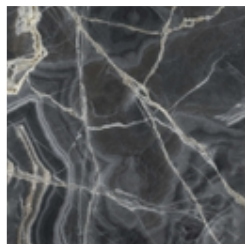

Glossy ceramic
Black Onyx

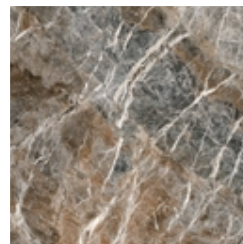

Glossy ceramic
Mountain peak

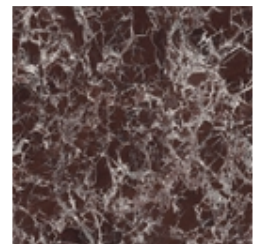

Glossy ceramic
Rosso imperiale

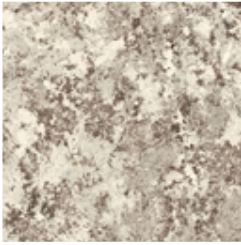

Mat ceramic
Alaska White



Mat ceramic
Augusta



Marble
Calacatta

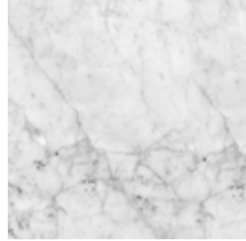

Marble
Carrara

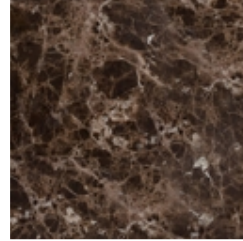

Marble
Emperador

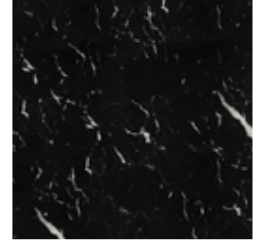

Marble
Marquinia

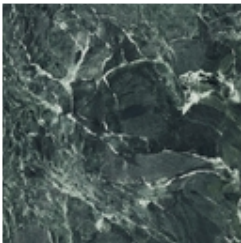

Marble
Saint Denis



Marble
Rosso Carpazi

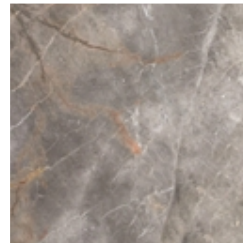

Marble
Fior di bosco



Marble
Travertino Romano

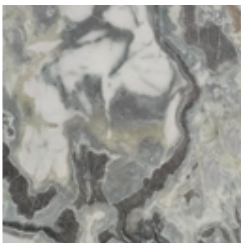

Marble
Dover White

Base

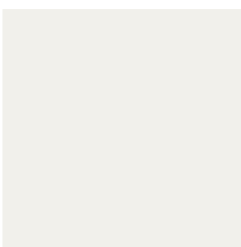

Painted metal
Mat white

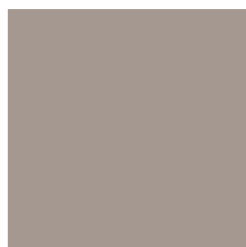

Painted metal
Mat dove grey



Painted metal
Supreme anthracite

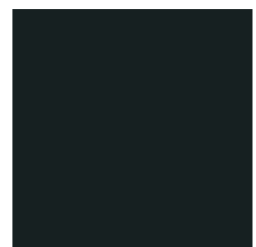

Painted metal
Mat black

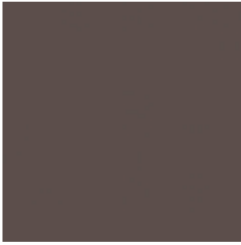

Painted metal
Mat brown



Painted metal
Mat bronze



Painted metal
Mat lead



Painted metal
Mat copper



Painted metal
Mat brass



Painted metal
Mat pearl gold

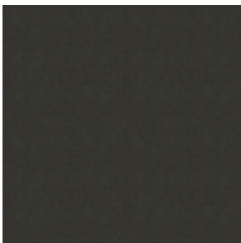

Metal finish
Burnished



Metal finish
Clouded chrome

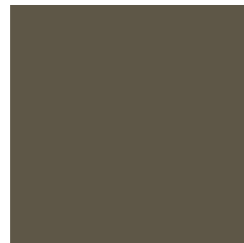

Metal finish
Brown nickel



Metal finish
Dark nickel

Materials, fabrics, leathers, colors and finishes are approximate and may slightly differ from actual ones. You can find the complete collection of Bonaldo fabrics and leathers on the website <https://bonaldo.biz>