

# BONALDO

## Luigio

Designer: Marconato and Zappa



The Luigio modern valet stand designed by Marconato & Zappa offers an extra service for the sleeping area. Three tubular metal elements emerge from the oval-shaped ceramic base, at the ends of which wooden elements with well-defined functions are mounted. The first ends in a coat hanger, carved in solid wood while the second element curves to form a support for trousers, but can also be used as a bag hook. The third, parallel to the first, ends with a storage container and a pocket emptier. In its formal elegance Luigio is a slender object ideal for giving order to the daily routine thanks to its practicality in use. The ceramic base is available in different finishes, even contrasting with the framework, thereby giving Luigio both a strong character and an original style.



# Data sheet

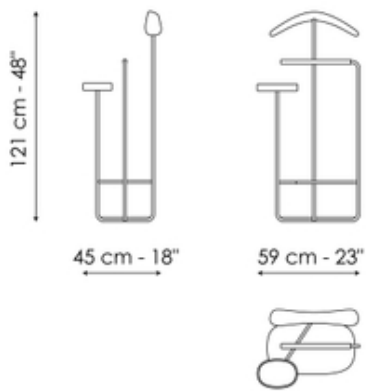

## Luigio

Width: 45cm

Depth: 59cm

Height: 121cm

# Finishes

## Structure



**Painted metal**  
Mat lead

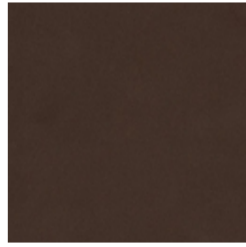

**Painted metal**  
Mat bronze

---

## Coat stand und Tray

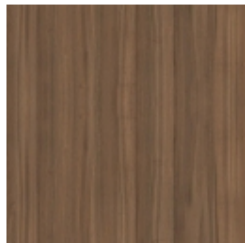

**Solid wood**  
Walnut Canaletto

---

# Base



**Mat ceramic**  
Ardesia grey

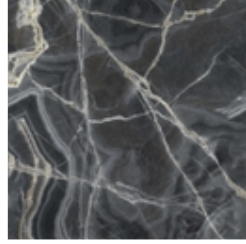

**Glossy ceramic**  
Black Onyx

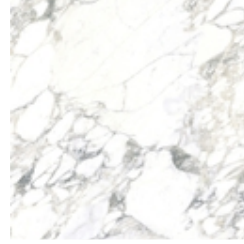

**Glossy ceramic**  
Calacatta

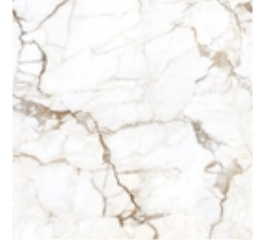

**Silk finish ceramic**  
Calacatta macchia vecchia

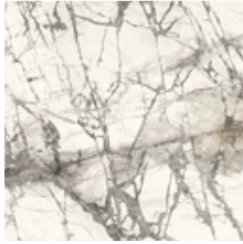

**Glossy ceramic**  
Imperial grey

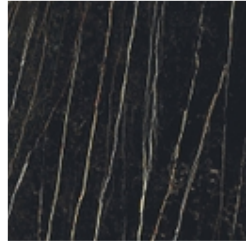

**Mat ceramic**  
Laurent

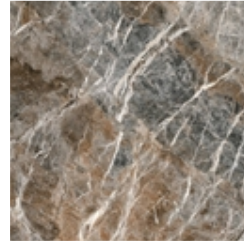

**Glossy ceramic**  
Mountain peak

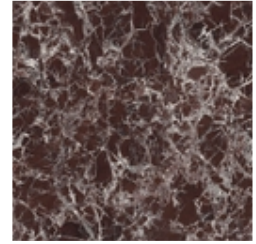

**Glossy ceramic**  
Rosso imperiale

---

Materials, fabrics, leathers, colors and finishes are approximate and may slightly differ from actual ones. You can find the complete collection of Bonaldo fabrics and leathers on the website <https://bonaldo.biz>