

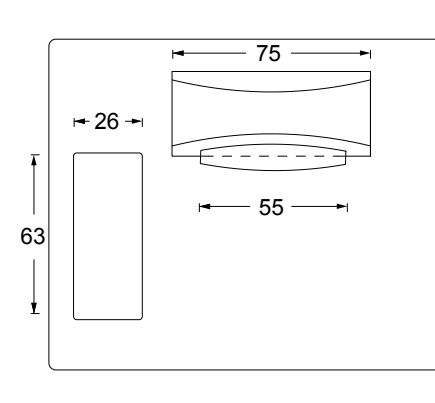

file 3D

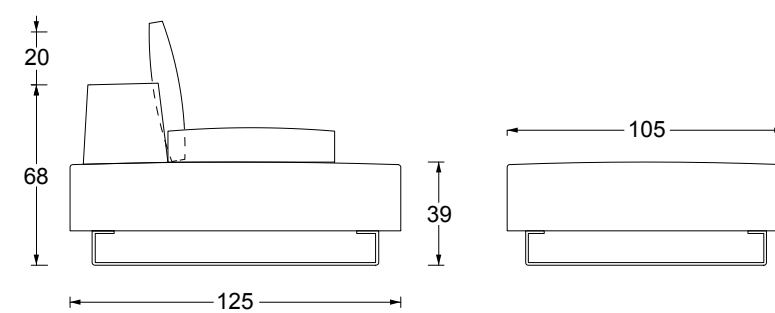
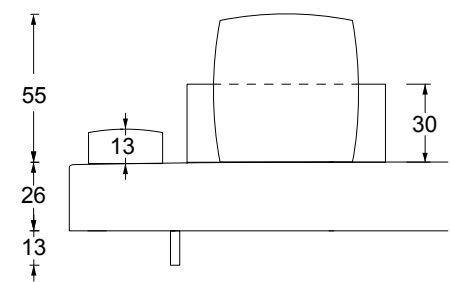

Completamente sfoderabile

- ① fibra di poliestere da 380 gr accoppiata con tela di cotone
- ② fibra di poliestere da 280 gr accoppiata con tela di cotone
- ③ poliuretano D30 IP
- ④ poliuretano D40 IP
- ⑤ poliuretano D35 IM
- ⑥ poliuretano D25 IP
- ⑦ struttura solida in MDF
- ⑧ barra in metallo
- ⑨ cinghie elastiche da 6 e 8 cm incrociate
- ⑩ multistrato e massello di pioppo e abete

pedi metallo verniciati nero opaco
pedi metacrilato optional

Completely removable cover

- ① 380 gr/mq polyester fibre covered with 100% cotton fabric
- ② 280 gr/mq polyester fibre covered with 100% fabric cotton
- ③ polyurethane foame D30 IP
- ④ polyurethane foam D40IP
- ⑤ polyurethane D35 IM
- ⑥ polyurethane D25 IP
- ⑦ MDF solid frame
- ⑧ metal bar
- ⑨ elastic belt 6/8 cm cross weft
- ⑩ plywood panels and poplar or pine solid wood

metal feet black matt pait
methacrylate feet optional

Base seduta

Base seats

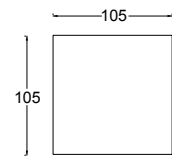

Descrizione Description	Codice Code	Lato Side	Tessuti - Fabrics				Pelle - Pelle			Tessuto cliente L./H. C.O.M. fabric L./H.
			Cat. B	Cat. C/D	Cat. Must	Cat. K	Cat. E	Cat. Plus	Cat. Luxury	
Espanso Foam	344CE0N 105x105									2,20/1,40
Fodera Cover	C44...									2,20/1,40

m³ 0,5 - kg. 20

Piedi in metacrilato
Methacrylate foot

Base seduta

Base seats

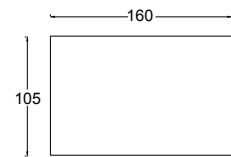

Descrizione Description	Codice Code	Lato Side	Tessuti - Fabrics				Pelle - Pelle			Tessuto cliente L./H. C.O.M. fabric L./H.
			Cat. B	Cat. C/D	Cat. Must	Cat. K	Cat. E	Cat. Plus	Cat. Luxury	
Espanso Foam	344CE0N 160x105									3,30/1,40
Fodera Cover	C44...									3,30/1,40

m³ 0,75 - kg. 30

Piedi in metacrilato
Methacrylate foot

Base seduta

Base seats

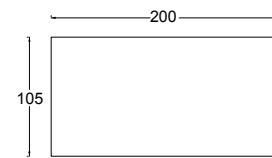

Descrizione Description	Codice Code	Lato Side	Tessuti - Fabrics				Pelle - Pelle			Tessuto cliente L./H. C.O.M. fabric L./H.
			Cat. B	Cat. C/D	Cat. Must	Cat. K	Cat. E	Cat. Plus	Cat. Luxury	
Espanso Foam	344CE0N 200x105									4,10/1,40
Fodera Cover	C44...									4,10/1,40

m³ 1,0 - kg. 37

Piedi in metacrilato
Methacrylate foot

Base seduta

Base seats

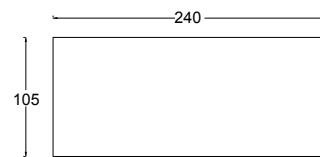

Descrizione Description	Codice Code	Lato Side	Tessuti - Fabrics				Pelle - Pelle			Tessuto cliente L./H. C.O.M. fabric L./H.
			Cat. B	Cat. C/D	Cat. Must	Cat. K	Cat. E	Cat. Plus	Cat. Luxury	
Espanso Foam	344CE0N 240x105									4,90/1,40
Fodera Cover	C44...									4,90/1,40

m³ 1,1 - kg. 40

Piedi in metacrilato
Methacrylate foot

Base seduta

Base seats

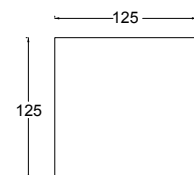

Descrizione Description	Codice Code	Lato Side	Tessuti - Fabrics				Pelle - Pelle			Tessuto cliente L./H. C.O.M. fabric L./H.
			Cat. B	Cat. C/D	Cat. Must	Cat. K	Cat. E	Cat. Plus	Cat. Luxury	
Espanso Foam	344CE0N 125x125									2,60/1,40
Fodera Cover	C44...									2,60/1,40

m³ 0,7 - kg. 28

Piedi in metacrilato
Methacrylate foot

Base seduta

Base seats

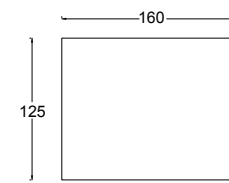

Descrizione Description	Codice Code	Lato Side	Tessuti - Fabrics				Pelle - Pelle			Tessuto cliente L./H. C.O.M. fabric L./H.
			Cat. B	Cat. C/D	Cat. Must	Cat. K	Cat. E	Cat. Plus	Cat. Luxury	
Espanso Foam	344CE0N 160x125									3,30/1,40
Fodera Cover	C44...									3,30/1,40

m³ 0,9 - kg. 36

Piedi in metacrilato
Methacrylate foot

Base seduta

Base seats

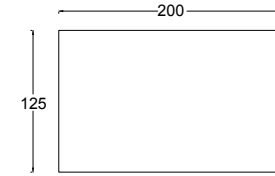

Descrizione Description	Codice Code	Lato Side	Tessuti - Fabrics				Pelle - Pelle			Tessuto cliente L./H. C.O.M. fabric L./H.
			Cat. B	Cat. C/D	Cat. Must	Cat. K	Cat. E	Cat. Plus	Cat. Luxury	
Espanso Foam	344CE0N 200x125									4,10/1,40
Fodera Cover	C44...									4,10/1,40

m³ 1,1 - kg. 45

Piedi in metacrilato
Methacrylate foot

Base seduta

Base seats

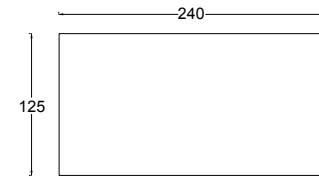

Descrizione Description	Codice Code	Lato Side	Tessuti - Fabrics				Pelle - Pelle			Tessuto cliente L./H. C.O.M. fabric L./H.
			Cat. B	Cat. C/D	Cat. Must	Cat. K	Cat. E	Cat. Plus	Cat. Luxury	
Espanso Foam	344CE0N 240x125									4,90/1,40
Fodera Cover	C44...									4,90/1,40

m³ 1,3 - kg. 50

Piedi in metacrilato
Methacrylate foot

Base diamante piccolo

Small diamond base

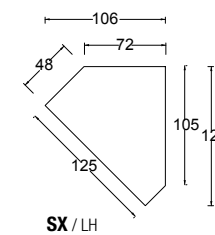

Descrizione Description	Codice Code	Lato Side	Tessuti - Fabrics				Pelle - Pelle			Tessuto cliente L./H. C.O.M. fabric L./H.
			Cat. B	Cat. C/D	Cat. Must	Cat. K	Cat. E	Cat. Plus	Cat. Luxury	
Espanso Foam	344CE0S 106x123 344CE0R 106x123	SX / LH DX / RH								2,10/1,40
Fodera Cover	C44...									2,10/1,40

m³ 0,7 - kg. 28

Piedi in metacrilato
Methacrylate foot

Base diamante

Diamond base

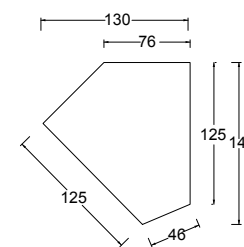

Descrizione Description	Codice Code	Lato Side	Tessuti - Fabrics				Pelle - Pelle			Tessuto cliente L./H. C.O.M. fabric L./H.
			Cat. B	Cat. C/D	Cat. Must	Cat. K	Cat. E	Cat. Plus	Cat. Luxury	
Espanso Foam	344CE0S 130x143 344CE0R 130x143	SX / LH DX / RH								2,60/1,40
Fodera Cover	C44...									2,60/1,40

m³ 1,1 - kg. 40

Piedi in metacrilato
Methacrylate foot

Schienale appoggio

Back frame free standing

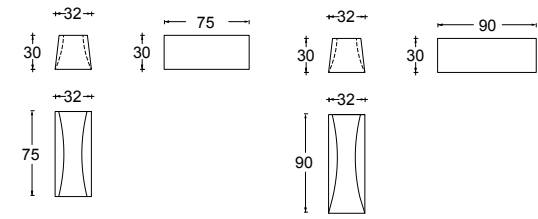

Descrizione Description	Codice Code	Lato Side	Tessuti - Fabrics				Pelle - Pelle			Tessuto cliente L./H. C.O.M. fabric L./H.
			Cat. B	Cat. C/D	Cat. Must	Cat. K	Cat. E	Cat. Plus	Cat. Luxury	
Espano Foam	344EEAN 75	75								0,90/1,40
Fodera Cover	C44...	75								0,90/1,40
Espano Foam	344EEAN 90	90								1,00/1,40
Fodera Cover	C44...	90								1,00/1,40

m³ 0,15 - kg. 17

Bracciolo appoggio

Armrest free standing

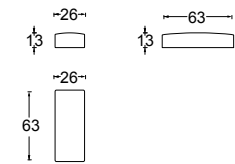

Descrizione Description	Codice Code	Lato Side	Tessuti - Fabrics				Pelle - Pelle			Tessuto cliente L./H. C.O.M. fabric L./H.
			Cat. B	Cat. C/D	Cat. Must	Cat. K	Cat. E	Cat. Plus	Cat. Luxury	
Espano Foam	344EEBN 65									0,70/1,40
Fodera Cover	C44...									0,70/1,40

m³ 0,05 - kg. 6

Rollò

Rollò

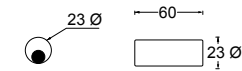

Descrizione Description	Codice Code	Lato Side	Tessuti - Fabrics				Pelle - Pelle			Tessuto cliente L./H. C.O.M. fabric L./H.
			Cat. B	Cat. C/D	Cat. Must	Cat. K	Cat. E	Cat. Plus	Cat. Luxury	
Espano Foam	344EEDN 60									0,65/1,40
Fodera Cover	C44...									0,65/1,40

m³ 0,05 - kg. 2

Cuscini schienale

Back cushions

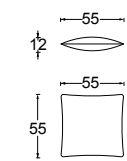

Descrizione Description	Codice Code	Lato Side	Tessuti - Fabrics				Pelle - Pelle			Tessuto cliente L./H. C.O.M. fabric L./H.
			Cat. B	Cat. C/D	Cat. Must	Cat. K	Cat. E	Cat. Plus	Cat. Luxury	
Piuma Feather	344EPBN 55x55									0,65/1,40
Fodera Cover	C44...									0,65/1,40

m³ 0,05 - kg. 2

Cuscini schienale con fascia

Back cushions with band

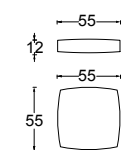

Descrizione Description	Codice Code	Lato Side	Tessuti - Fabrics				Pelle - Pelle			Tessuto cliente L./H. C.O.M. fabric L./H.
			Cat. B	Cat. C/D	Cat. Must	Cat. K	Cat. E	Cat. Plus	Cat. Luxury	
Piuma Feather	344EPCN 55x55									2,60/1,40
Fodera Cover	C44...									2,60/1,40

m³ 0,05 - kg. 2

Esempi di composizioni 1

Examples of arrangements 1

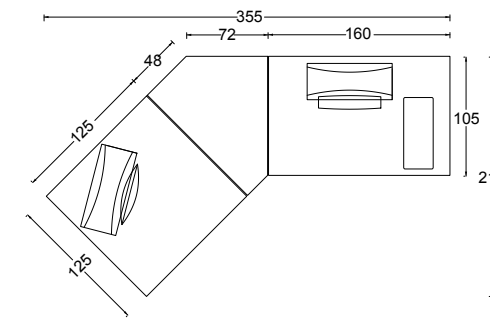

Descrizione Description	Codice Code	Lato Side	Tessuti - Fabrics				Pelle - Pelle			Tessuto cliente L./H. C.O.M. fabric L./H.
			Cat. B	Cat. C/D	Cat. Must	Cat. K	Cat. E	Cat. Plus	Cat. Luxury	
Espano Foam	COMP. 1									11,80/1,40

Codici elementi composizione
Codes of composition elements

344CEON 125x125 (x1) + 344CE0S 106x123 (x1) + 344CEON 160x105 (x1) + 344EEAN 75 (x2) + 344EEBN 65 (x1) + 344EEBN 55x55 (x1) + 344EECN 55x55 (x1)

Esempi di composizioni 2

Examples of arrangements 2

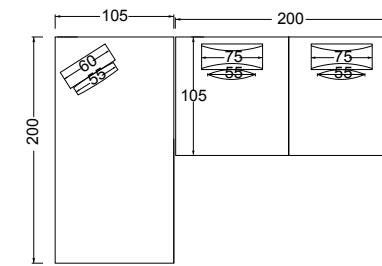

Descrizione Description	Codice Code	Lato Side	Tessuti - Fabrics				Pelle - Pelle			Tessuto cliente L./H. C.O.M. fabric L./H.
			Cat. B	Cat. C/D	Cat. Must	Cat. K	Cat. E	Cat. Plus	Cat. Luxury	
Espano Foam	COMP. 2									8,50/1,40

Codici elementi composizione
Codes of composition elements

344CEON 200x105 (x2) + 344EEAN 75 (x2) + 344EEDN 60 (x1) + 344EEBN 55x55 (x2) + 344EECN 55x55 (x1)

Esempi di composizioni 3

Examples of arrangements 3

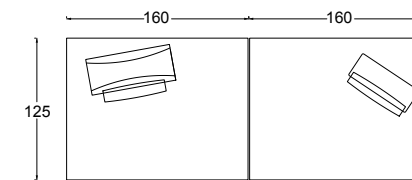

Descrizione Description	Codice Code	Lato Side	Tessuti - Fabrics				Pelle - Pelle			Tessuto cliente L./H. C.O.M. fabric L./H.
			Cat. B	Cat. C/D	Cat. Must	Cat. K	Cat. E	Cat. Plus	Cat. Luxury	
Espano Foam	COMP. 3									9,45/1,40

Codici elementi composizione
Codes of composition elements

344CEON 160x125 (x2) + 344EEAN 75 (x1) + 344EEDN 60 (x1) + 344EECN 55x55 (x2)

Esempi di composizioni 4

Examples of arrangements 4

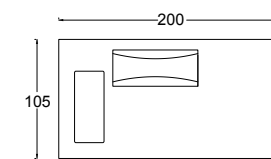

Descrizione Description	Codice Code	Lato Side	Tessuti - Fabrics				Pelle - Pelle			Tessuto cliente L./H. C.O.M. fabric L./H.
			Cat. B	Cat. C/D	Cat. Must	Cat. K	Cat. E	Cat. Plus	Cat. Luxury	
Espano Foam	COMP. 4									5,70/1,40

Codici elementi composizione
Codes of composition elements

344CEON 200x105 (x1) + 344EEAN 75 (x1) + 344EEBN 65 (x1)

Esempi di composizioni 5

Examples of arrangements 5

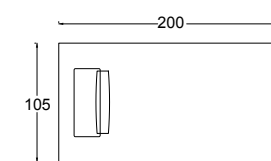

Descrizione Description	Codice Code	Lato Side	Tessuti - Fabrics				Pelle - Pelle			Tessuto cliente L./H. C.O.M. fabric L./H.
			Cat. B	Cat. C/D	Cat. Must	Cat. K	Cat. E	Cat. Plus	Cat. Luxury	
Espano Foam	COMP. 5									5,40/1,40

Codici elementi composizione
Codes of composition elements

344CEON 200x105 (x1) + 344EEDN 60 (x1) + 344EECN 55x55 (x1)