

file 3D



Completamente sfoderabile

- ❶ fibra di poliestere da 380 gr accoppiata con tela di cotone 100%
- ❷ poliuretano D30 IP
- ❸ poliuretano D40 IP
- ❹ poliuretano D24 IM super soft
- ❺ cinghie elastiche da 6 e 8 cm incrociate
- ❻ multistrato in massello di pioppo e abete

piedi H. 4 cm

Completely removable cover

- ❶ Velcover 380 gr covered with cotton fabric
- ❷ polyurethane D30 IP
- ❸ polyurethane D40 IP
- ❹ super soft polyurethane D24 IM
- ❺ elastic belts 6/8 cm cross weft
- ❻ plywood and solid poplar and fir

Feet H. 4 cm

Base seduta

Base seats

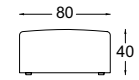
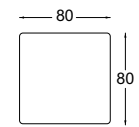

Descrizione Description	Codice Code	Lato Side	Tessuti - Fabrics				Pelle - Pelle			Tessuto cliente L./H. C.O.M. fabric L./H.
			Cat. B	Cat. C/D	Cat. Must	Cat. K	Cat. E	Cat. Plus	Cat. Luxury	
Espanso Foam	36LCEON 080									1,90/1,40
Fodera Cover	C6LCEON 080									1,90/1,40

m³ 0,35 - kg. 27

Base seduta

Base seats

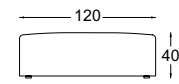
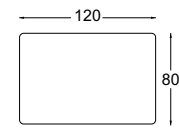

Descrizione Description	Codice Code	Lato Side	Tessuti - Fabrics				Pelle - Pelle			Tessuto cliente L./H. C.O.M. fabric L./H.
			Cat. B	Cat. C/D	Cat. Must	Cat. K	Cat. E	Cat. Plus	Cat. Luxury	
Espanso Foam	36LCEON 120									2,75/1,40
Fodera Cover	C6LCEON 120									2,75/1,40

m³ 0,50 - kg. 27

Base seduta

Base seats

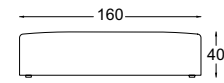
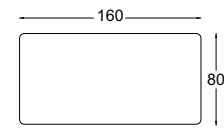

Descrizione Description	Codice Code	Lato Side	Tessuti - Fabrics				Pelle - Pelle			Tessuto cliente L./H. C.O.M. fabric L./H.
			Cat. B	Cat. C/D	Cat. Must	Cat. K	Cat. E	Cat. Plus	Cat. Luxury	
Espanso Foam	36LCEON 160									3,65/1,40
Fodera Cover	C6LCEON 160									3,65/1,40

m³ 0,70 - kg. 44

Base seduta

Base seats

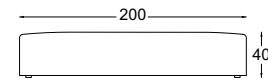
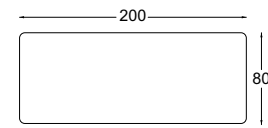

Descrizione Description	Codice Code	Lato Side	Tessuti - Fabrics				Pelle - Pelle			Tessuto cliente L./H. C.O.M. fabric L./H.
			Cat. B	Cat. C/D	Cat. Must	Cat. K	Cat. E	Cat. Plus	Cat. Luxury	
Espanso Foam	36LCEON 200									4,55/1,40
Fodera Cover	C6LCEON 200									4,55/1,40

m³ 0,80 - kg. 55

Base seduta

Base seats

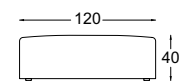
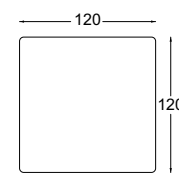

Descrizione Description	Codice Code	Lato Side	Tessuti - Fabrics				Pelle - Pelle			Tessuto cliente L./H. C.O.M. fabric L./H.
			Cat. B	Cat. C/D	Cat. Must	Cat. K	Cat. E	Cat. Plus	Cat. Luxury	
Espanso Foam	36LCEON 120120									2,75/1,40
Fodera Cover	C6LCEON 120120									2,75/1,40

m³ 0,70 - kg. 45

Seduta pentangolo

Pentangle seat

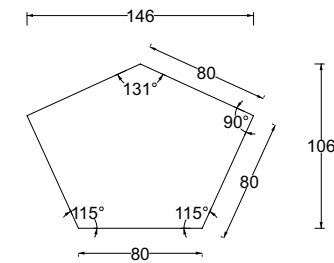

Descrizione Description	Codice Code	Lato Side	Tessuti - Fabrics				Pelle - Pelle			Tessuto cliente L./H. C.O.M. fabric L./H.
			Cat. B	Cat. C/D	Cat. Must	Cat. K	Cat. E	Cat. Plus	Cat. Luxury	
Espanso Foam	36LCE4. 146									7,30/1,40
Fodera Cover	C6LCE4. 146									7,30/1,40

m³ 0,90 - kg. 45

Seduta goccia

Drop seat

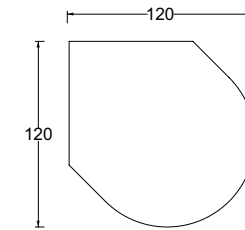

Descrizione Description	Codice Code	Lato Side	Tessuti - Fabrics				Pelle - Pelle			Tessuto cliente L./H. C.O.M. fabric L./H.
			Cat. B	Cat. C/D	Cat. Must	Cat. K	Cat. E	Cat. Plus	Cat. Luxury	
Espanso Foam	36LCE2. 120									7,80/1,40
Fodera Cover	C6LCE2. 120									7,80/1,40

m³ 0,90 - kg. 45

Cuscino schienale 56x56

Back cushion

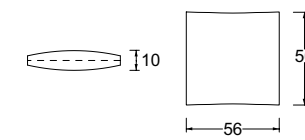

Descrizione Description	Codice Code	Lato Side	Tessuti - Fabrics				Pelle - Pelle			Tessuto cliente L./H. C.O.M. fabric L./H.
			Cat. B	Cat. C/D	Cat. Must	Cat. K	Cat. E	Cat. Plus	Cat. Luxury	
Piuma Feather	36LEPCN 056	H. 56								0,75/1,40
Fodera Cover	C6LEPBN 056	H. 56								0,75/1,40

m³ 0,05 - kg. 3,0

Cuscino schienale con rollò 65x60

Back cushion with rollò

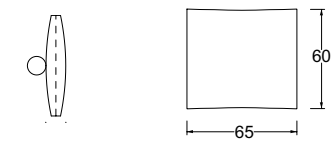

Descrizione Description	Codice Code	Lato Side	Tessuti - Fabrics				Pelle - Pelle			Tessuto cliente L./H. C.O.M. fabric L./H.
			Cat. B	Cat. C/D	Cat. Must	Cat. K	Cat. E	Cat. Plus	Cat. Luxury	
Piuma Feather	36LEPCN 065	H. 60								1,75/1,40
Fodera Cover	C6LEPCN 065	H. 60								1,75/1,40

m³ 0,06 - kg. 3,5

Cuscino schienale con sostegno interno 56x56

Back cushion with internal support

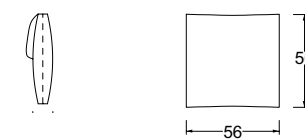

Descrizione Description	Codice Code	Lato Side	Tessuti - Fabrics				Pelle - Pelle			Tessuto cliente L./H. C.O.M. fabric L./H.
			Cat. B	Cat. C/D	Cat. Must	Cat. K	Cat. E	Cat. Plus	Cat. Luxury	
Piuma Feather	36LEPCN 056S	H. 56								1,75/1,40
Fodera Cover	C6LEPCN 056	H. 56								1,75/1,40

m³ 0,05 - kg. 3,0

Base schienale da 80

Backrest base 80

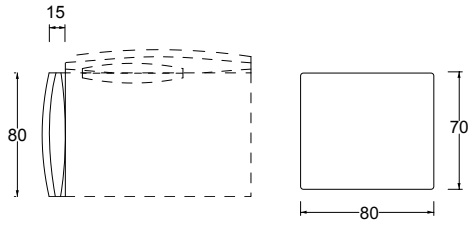

Descrizione Description	Codice Code	Lato Side	Tessuti - Fabrics				Pelle - Pelle			Tessuto cliente L./H. C.O.M. fabric L./H.
			Cat. B	Cat. C/D	Cat. Must	Cat. K	Cat. E	Cat. Plus	Cat. Luxury	
Espanso Foam	36LCEAN 080	H. 70								1,60/1,40
Fodera Cover	C6LCEAN 080	H. 70								1,60/1,40

m² 0,08 - kg. 8,0

Base schienale da 120

Backrest base 120

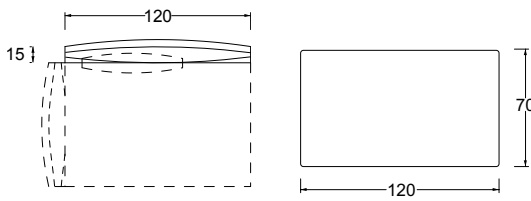

Descrizione Description	Codice Code	Lato Side	Tessuti - Fabrics				Pelle - Pelle			Tessuto cliente L./H. C.O.M. fabric L./H.
			Cat. B	Cat. C/D	Cat. Must	Cat. K	Cat. E	Cat. Plus	Cat. Luxury	
Espanso Foam	36LCEAN 120	H. 70								2,30/1,40
Fodera Cover	C6LCEAN 120	H. 70								2,30/1,40

m² 0,15 - kg. 12,0

Bracciolo 40x80

Armrest 40x80

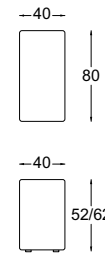

Descrizione Description	Codice Code	Lato Side	Tessuti - Fabrics				Pelle - Pelle			Tessuto cliente L./H. C.O.M. fabric L./H.
			Cat. B	Cat. C/D	Cat. Must	Cat. K	Cat. E	Cat. Plus	Cat. Luxury	
Espanso Foam	36LCEBN	H. 52								1,95/1,40
Fodera Cover	C6LCEBN 040080052	H. 52								1,95/1,40
Espanso Foam	36LCEBN	H. 62								1,95/1,40
Fodera Cover	C6LCEBN 040080062	H. 62								1,95/1,40

m² 0,20 - kg. 21

Bracciolo 40x120

Armrest 40x120

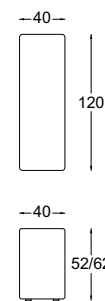

Descrizione Description	Codice Code	Lato Side	Tessuti - Fabrics				Pelle - Pelle			Tessuto cliente L./H. C.O.M. fabric L./H.
			Cat. B	Cat. C/D	Cat. Must	Cat. K	Cat. E	Cat. Plus	Cat. Luxury	
Espanso Foam	36LCEBN	H. 52								2,75/1,40
Fodera Cover	C6LCEBN 040120052	H. 52								2,75/1,40
Espanso Foam	36LCEBN	H. 62								2,75/1,40
Fodera Cover	C6LCEBN 040120062	H. 62								2,75/1,40

m² 0,30 - kg. 28

Bracciolo 25x80

Armrest 25x80

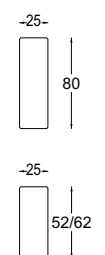

Descrizione Description	Codice Code	Lato Side	Tessuti - Fabrics				Pelle - Pelle			Tessuto cliente L./H. C.O.M. fabric L./H.
			Cat. B	Cat. C/D	Cat. Must	Cat. K	Cat. E	Cat. Plus	Cat. Luxury	
Espanso Foam	36LCEBN	H. 52								1,30/1,40
Fodera Cover	C6LCEBN 025080052	H. 52								1,30/1,40
Espanso Foam	36LCEBN	H. 62								1,90/1,40
Fodera Cover	C6LCEBN 025080062	H. 62								1,90/1,40

m² 0,15 - kg. 16

Bracciolo 25x105

Armrest 25x105

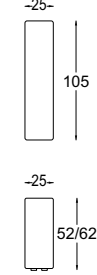

Descrizione Description	Codice Code	Lato Side	Tessuti - Fabrics				Pelle - Pelle			Tessuto cliente L./H. C.O.M. fabric L./H.
			Cat. B	Cat. C/D	Cat. Must	Cat. K	Cat. E	Cat. Plus	Cat. Luxury	
Espanso Foam	36LCEBN	H. 52								1,55/1,40
Fodera Cover	C6LCEBN 025105052	H. 52								1,55/1,40
Espanso Foam	36LCEBN	H. 62								2,40/1,40
Fodera Cover	C6LCEBN 025105062	H. 62								2,40/1,40

m² 0,17 - kg. 22

Bracciolo 25x120

Armrest 25x120

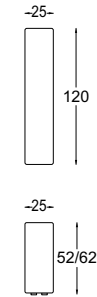

Descrizione Description	Codice Code	Lato Side	Tessuti - Fabrics				Pelle - Pelle			Tessuto cliente L./H. C.O.M. fabric L./H.
			Cat. B	Cat. C/D	Cat. Must	Cat. K	Cat. E	Cat. Plus	Cat. Luxury	
Espanso Foam	36LCEBN	H. 52								1,75/1,40
Fodera Cover	C6LCEBN 025120052	H. 52								1,75/1,40
Espanso Foam	36LCEBN	H. 62								2,75/1,40
Fodera Cover	C6LCEBN 025120062	H. 62								2,75/1,40

m² 0,25 - kg. 25

Rollo con zavorra interna

Rollò with ballast

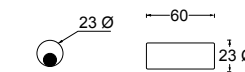

Descrizione Description	Codice Code	Lato Side	Tessuti - Fabrics				Pelle - Pelle			Tessuto cliente L./H. C.O.M. fabric L./H.
			Cat. B	Cat. C/D	Cat. Must	Cat. K	Cat. E	Cat. Plus	Cat. Luxury	
Espanso Foam	36LEEDN									0,75/1,40
Fodera Cover	C3LEEDN									0,75/1,40

m³ 0,05 - kg. 6

Esempi di composizioni 1

Examples of arrangements 1

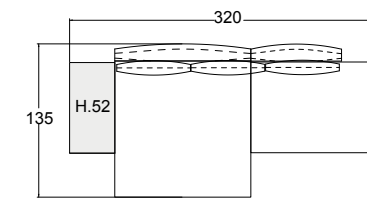

Descrizione Description	Codice Code	Lato Side	Tessuti - Fabrics				Pelle - Pelle			Tessuto cliente L./H. C.O.M. fabric L./H.
			Cat. B	Cat. C/D	Cat. Must	Cat. K	Cat. E	Cat. Plus	Cat. Luxury	
Espanso Foam	COMP. 1									13,60/1,40

Codici elementi composizione

Codes of composition elements

36LCEAN 40x80x52 (x1) + 36LCEAN 120 (x1) + 36LCEAN 80 (x1) + 36LCEAN 120x120 (x1) + 36LCEAN 120 (x1) + 36LEPBN 56x56 (x3)

Esempi di composizioni 2

Examples of arrangements 2

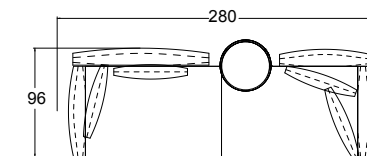

Descrizione Description	Codice Code	Lato Side	Tessuti - Fabrics				Pelle - Pelle			Tessuto cliente L./H. C.O.M. fabric L./H.
			Cat. B	Cat. C/D	Cat. Must	Cat. K	Cat. E	Cat. Plus	Cat. Luxury	
Espanso Foam	COMP. 2									15,60/1,40

Codici elementi composizione

Codes of composition elements

36LCEAN 120 (x2) + 36LCEAN 80 (x3) + 36LCEAN 120 (x1) + 36LEPCN 56x56 (x4) + Tavolino Orion tondo (x1)

Esempi di composizioni 3

Examples of arrangements 3

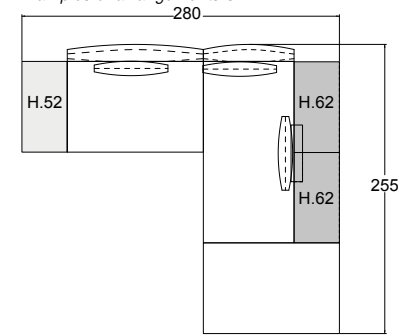

Descrizione Description	Codice Code	Lato Side	Tessuti - Fabrics				Pelle - Pelle			Tessuto cliente L./H. C.O.M. fabric L./H.
			Cat. B	Cat. C/D	Cat. Must	Cat. K	Cat. E	Cat. Plus	Cat. Luxury	
Espano Foam	COMP. 3									23,60/1,40

Codici elementi composizione
Codes of composition elements
36LCEON 160 (x1) + 36LCEON 120 (x2) + 36LCE9N 40x80x52 (x1) + 36LCE9 40x80x62 (x2) + 36LCEAN 80 (x1) + 36LCEO 120 (x1) + 36LEPCN (x1) + 36LEPBN 56x56 (x2)

Esempi di composizioni 4

Examples of arrangements 4

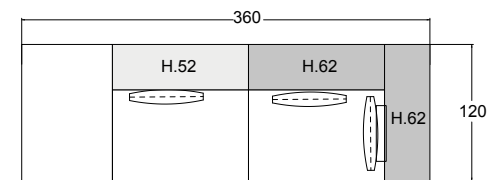

Descrizione Description	Codice Code	Lato Side	Tessuti - Fabrics				Pelle - Pelle			Tessuto cliente L./H. C.O.M. fabric L./H.
			Cat. B	Cat. C/D	Cat. Must	Cat. K	Cat. E	Cat. Plus	Cat. Luxury	
Espano Foam	COMP. 4									22,70/1,40

Codici elementi composizione
Codes of composition elements
36LCEON 120 (x3) + 36LCE9N 40x80x52 (x1) + 36LCE9N 40x120x62 (x2) + 36LEPCM 56x56 (x2) + 36LEPCN (x1)

Esempi di composizioni 5

Examples of arrangements 5

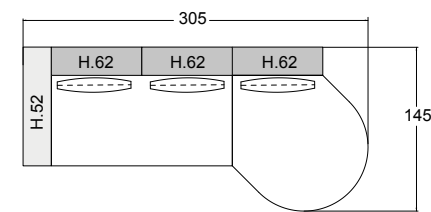

Descrizione Description	Codice Code	Lato Side	Tessuti - Fabrics				Pelle - Pelle			Tessuto cliente L./H. C.O.M. fabric L./H.
			Cat. B	Cat. C/D	Cat. Must	Cat. K	Cat. E	Cat. Plus	Cat. Luxury	
Espano Foam	COMP. 5									22,50/1,40

Codici elementi composizione
Codes of composition elements
36LCE2 120 (x1) + 36LCEON 160 (x1) + 36LCE9N 25x105x52 (x1) + 36LCE9N 25x80x62 (x3) + 36LEPCN 56x56 (x3)

Esempi di composizioni 6

Examples of arrangements 6

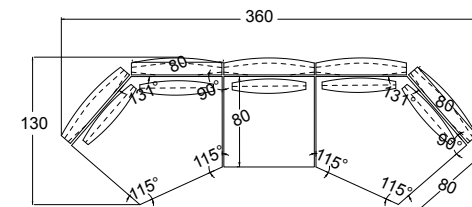

Descrizione Description	Codice Code	Lato Side	Tessuti - Fabrics				Pelle - Pelle			Tessuto cliente L./H. C.O.M. fabric L./H.
			Cat. B	Cat. C/D	Cat. Must	Cat. K	Cat. E	Cat. Plus	Cat. Luxury	
Espano Foam	COMP. 6									33,25/1,40

Codici elementi composizione
Codes of composition elements
36LCE4N 146 (x2) + 36LCEON 80 (x1) + 36LCEAN 80 (x5) + 36LEPCN (x5)

Esempi di composizioni 7

Examples of arrangements 7

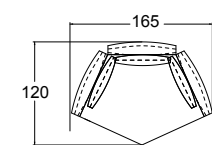

Descrizione Description	Codice Code	Lato Side	Tessuti - Fabrics				Pelle - Pelle			Tessuto cliente L./H. C.O.M. fabric L./H.
			Cat. B	Cat. C/D	Cat. Must	Cat. K	Cat. E	Cat. Plus	Cat. Luxury	
Espano Foam	COMP. 7									14,35/1,40

Codici elementi composizione
Codes of composition elements
36LCE4 146 (x1) + 36LCEAN 80 (x3) + 36LEPCM (x3)

Esempi di composizioni 8

Examples of arrangements 8

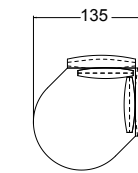

Descrizione Description	Codice Code	Lato Side	Tessuti - Fabrics				Pelle - Pelle			Tessuto cliente L./H. C.O.M. fabric L./H.
			Cat. B	Cat. C/D	Cat. Must	Cat. K	Cat. E	Cat. Plus	Cat. Luxury	
Espano Foam	COMP. 8									14,50/1,40

Codici elementi composizione
Codes of composition elements
36LCE2N 120 (x1) + 36LCEAN 80 (x2) + 36LEPBN 56x56 (x2)

